

Synthetic Quartz Glass Substrates for Nano-Imprint Templates

VIOSIL-SQ, SX (TS series)

A growing number of companies are focusing on the development of devices using nano-imprint technologies. These devices include semiconductors, storage devices, optical parts, biochips and various MEMS devices. Shin-Etsu has developed a new line of synthetic quartz substrates for nano-imprint templates based upon our cutting edge production technologies.

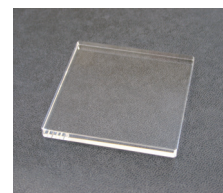

Features

- Transmissivity : High transmissivity to deep UV — ideal for UV nano-imprints.
- UV-resistance : UV-resistance has been established from extensive use in photomask substrates.
- Low Thermal Expansion : Synthetic Quartz offers high stability when exposed to temperature variations.
- High heat-resistance & mechanical strength : Substrates can be used for years, leading to reduced cost.
- Dimensional accuracy : Shin-Etsu synthetic quartz is manufactured to meet the strictest dimensional requirements.
- Flatness : Flatness specifications are in sub-micron ranges.
- Surface : Technologies used in photomask substrates insures no defects and low surface roughness averages.

Transmission Curve

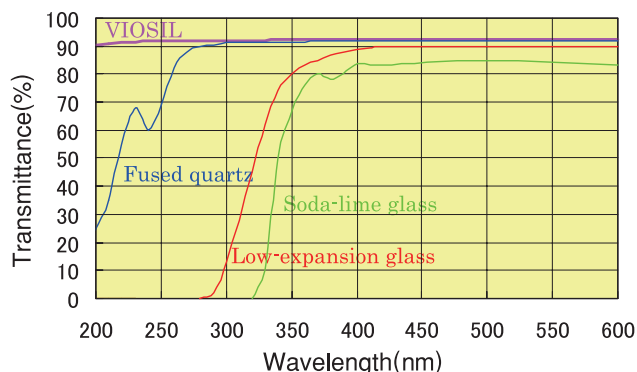

Mechanical Properties

Mechanical Properties	Unit	VIOSIL
Specific gravity	g/cm ³	2.202
Poisson's ratio		0.17
Young's modulus	kg/mm ²	7380
Shear modulus	kg/mm ²	3150
Vicker's hardness	kg/mm ²	784

Polished Surface of Substrate (Micro Roughness)

P-grade (Ra ≤ 1.0 nm)

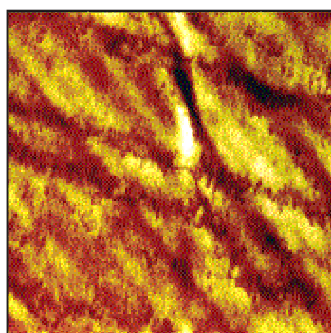

W-grade (Ra ≤ 0.3 nm)

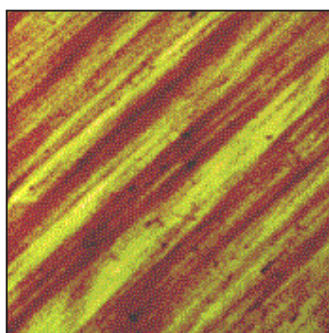

S-grade (Ra ≤ 0.2 nm)

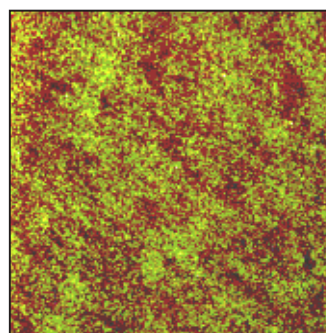

Measured with AFM (Atomic Force Microscope), 1μm² area.

Shin-Etsu

Contact us : Shin-Etsu Chemical Co., Ltd. Advanced Materials Division
 TEL +81-(0)3-3246-5222, FAX +81-(0)3-3246-6839, E-mail : r_nakata@shinetsu.jp

Examples of line-ups

Products	Edge length and thickness	Squareness	Straightness	Flatness	Roughness
TS2525WE	65mm×65mm×6.35mm [†] (Square)	≦3min.	≦4 μm	≦1 μm	W-grade
TS2525SE	65mm×65mm×6.35mm [†] (Square)	≦3min.	≦4 μm	≦0.5 μm	S-grade
Others	We can produce square, rectangular or round plates of various specification.				

※Squareness: between side faces and between side face and surface. ; Straightness: maximum PV in side surfaces. ; Flatness: 10mm-less area from the edge. ; Roughness: refer to “Polished Surface of Substrate (Micro Roughness)”, previous page.

Processing

Nano-imprint templates are produced from 6025 quartz substrates. Mesas are formed for the pattern areas. The patterned substrate is then diced and edge polished. (6025 quartz substrates are the standard material used for LSI-photomask production.) Some processes start with quartz substrates in other shapes and or sizes, either square or round. Shin-Etsu has developed the technology and expertise to provide a full range of products and services for nano-imprint processing. Shin-Etsu can provide the base 6025 substrate either blank or with etched mesas. After the patterns are on the templates they can be returned to Shin-Etsu for dicing and edge-polishing. Various shapes either flat or with mesas or hollows can easily be produced to meet your requirements.

《Processing of patterned quartz substrates (example)》

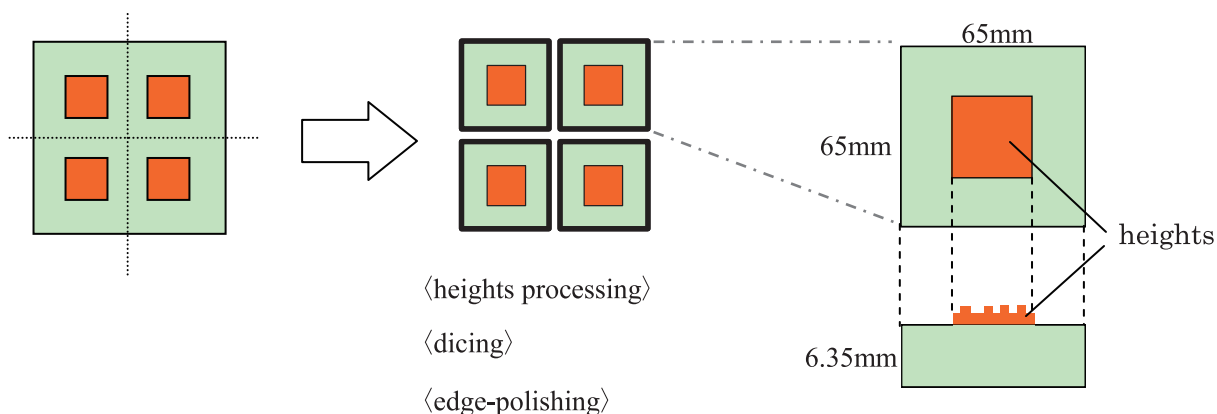

《Heights-processed quartz wafers, hollow-processed quartz wafers (example)》

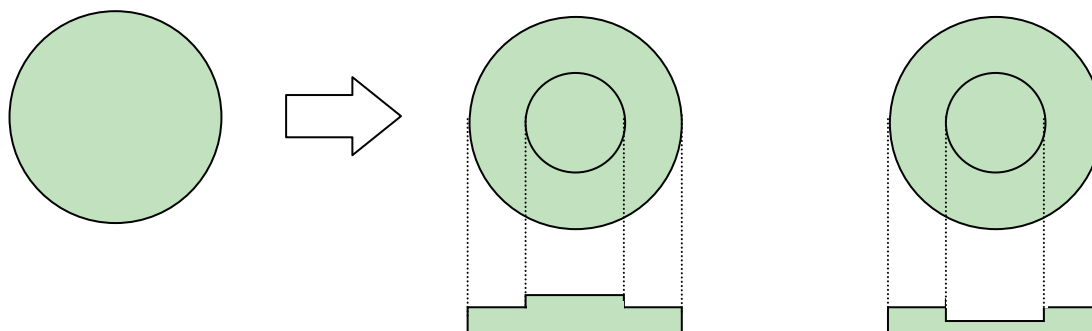

Shin-Etsu

Contact us : Shin-Etsu Chemical Co., Ltd. Advanced Materials Division
 TEL +81-(0)3-3246-5222, FAX +81-(0)3-3246-6839, E-mail : r_nakata@shinetsu.jp